

BIMM 143
Introduction to UNIX
 Barry Grant
 UC San Diego
<http://thegrantlab.org/bimm143>

Lets get started...

Mac Terminal

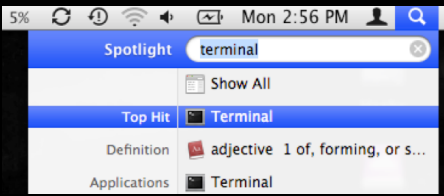

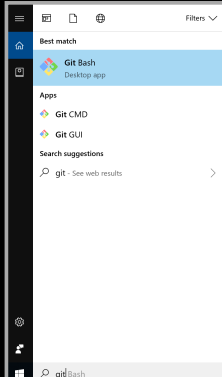
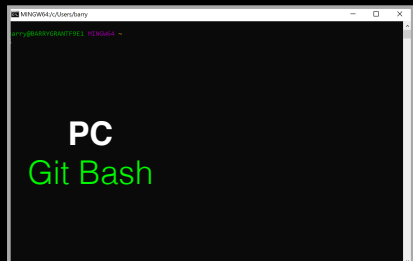

PC
 Git Bash

Do it Yourself!

SideNote: **Terminal** vs **Shell**

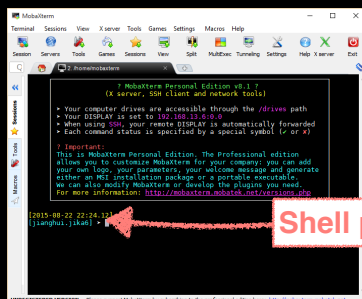
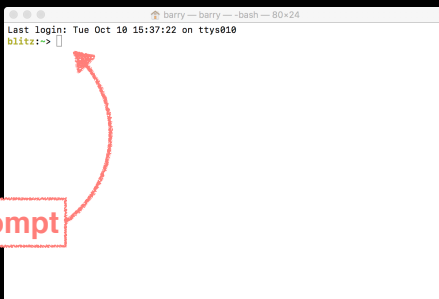
- **Shell**: A command-line interface that allows a user to interact with the operating system by typing commands.
- **Terminal [emulator]**: A graphical interface to the shell (*i.e.* the window you get when you launch Git Bash/iTerm/etc.).

Shell prompt

Introduction To UNIX



Introduction To UNIX Shell



Do it Yourself!

```
2. class-material (bash)
# Print Working Directory: .a.k.a. where the hell am I? This is a comment line
> pwd This is our first UNIX command :-)
```

Don't type the ">" bit it is the "shell prompt"!

```
# List out the files and directories where you are
> ls
```

Q. What do you see after each command?

Q. Does it make sense if you compare to your Mac: *Finder* or Windows: *File Explorer*?

```
# On Mac only :(
> open .
# Note the [SPACE] is important
```

```
2. class-material (bash)
# Download any file to your current directory/folder
> curl -O https://bioboot.github.io/bggn213_S18/class-material/bggn213_01_unix.zip
```

Q. Does what you see at each step make sense if you compare to your Mac: *Finder* or Windows: *File Explorer*?

```
2. class-material (bash)
# Download any file to your current directory/folder
> curl -O https://bioboot.github.io/bggn213_S18/class-material/bggn213_01_unix.zip

# List out the files and directories where you are (NB: Use TAB for auto-complete)
> ls bggn213_01_unix.zip

# Un-zip your downloaded file
> unzip bggn213_01_unix.zip

# Change directory (i.e. move to the folder named bggn213_01_unix)
> cd bggn213_01_unix

> ls
> pwd
```

Q. Does what you see at each step make sense if you compare to your Mac: *Finder* or Windows: *File Explorer*?

```
2. class-material (bash)
# Practice moving around the file system...
> cd projects
> ls
> pwd
> cd ..
```

Motivation

Why do we use Unix?

| | |
|------------------------|---|
| Modularity | Core programs are modular and work well with others |
| Programmability | Best software development environment |
| Infrastructure | Access to existing tools and cutting-edge methods |
| Reliability | Unparalleled uptime and stability |
| Unix Philosophy | Encourages open standards |

| | |
|------------------------|---|
| Modularity | Core programs are modular and work well with others |
| Programmability | Best software development environment |
| Infrastructure | Access to existing tools and cutting-edge methods |
| Reliability | Unparalleled uptime and stability |
| Unix Philosophy | Encourages open standards |

Modularity

The Unix shell was designed to allow users to easily build complex workflows by interfacing smaller **modular programs** together.



An alternative approach is to write a **single complex program** that takes raw data as input, and after hours of data processing, outputs publication figures and a final table of results.

All-in-one custom 'Monster' program

Advantages/Disadvantages

The 'monster approach' is **customized to a particular project** but results in **massive, fragile** and difficult to modify (therefore **inflexible, untransferable, and error prone**) code.

With **modular workflows**, it's easier to:

- **Spot errors** and figure out where they're occurring by inspecting intermediate results.
- **Experiment** with alternative methods by swapping out components.
- **Tackle novel problems** by remixing existing modular tools.

Unix 'Philosophy'

"Write programs that do one thing and do it well. Write programs to work together and that encourage open standards. Write programs to handle text streams, because that is a universal interface."



— Doug McIlroy

Unix family tree [1969-2010]

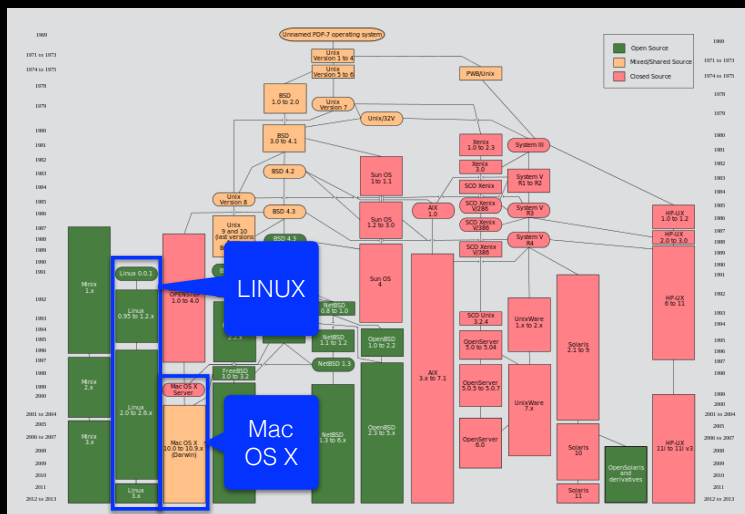

Source: https://commons.wikimedia.org/wiki/File:Unix_history-simple.svg

| Basics | File Control | Viewing & Editing Files | Misc. useful | Power commands | Process related |
|--------|-----------------------|-------------------------|--------------|----------------|-----------------|
| ls | mv | less | curl | grep | top |
| cd | cp | head | chmod | find | ps |
| pwd | mkdir | tail | wc | sed | kill |
| man | rm | nano | echo | sudo | Ctrl-c |
| ssh | (pipe) | touch | source | git | Ctrl-z |
| scp | > (write to file) | | cat | R | bg |
| | < (read from file) | | tmux | python | fg |

| Basics | File Control | Viewing & Editing Files | Misc. useful | Power commands | Process related |
|--------|-----------------------|-------------------------|--------------|----------------|-----------------|
| ls | mv | less | curl | grep | top |
| cd | cp | head | chmod | find | ps |
| pwd | mkdir | tail | wc | sed | kill |
| man | rm | nano | echo | sudo | Ctrl-c |
| ssh | (pipe) | touch | source | git | Ctrl-z |
| scp | > (write to file) | | cat | R | bg |
| | < (read from file) | | tmux | python | fg |

Beginning Unix

Getting started with basic Unix commands

Information in the **file system** is stored in files, which are stored in **directories** (folders). Directories can also store other directories, which forms a **directory tree**.

Re-Cap!

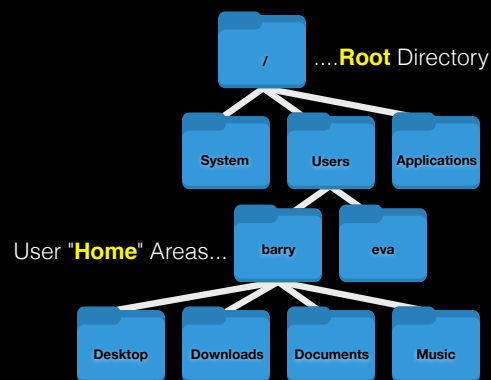

The forward slash character **'/'** is used to represent the **root** directory of the whole file system, and is also used to separate directory names.
E.g. **/Users/barry/Desktop/myfile.csv**

UNIX Basics: Using the filesystem

| | |
|--------------|--|
| ls | List files and directories |
| cd | Change directory (i.e. move to a different 'folder') |
| pwd | Print working directory (which folder are you in) |
| mkdir | MaKe a new DIRectories |
| cp | CoPy a file or directory to somewhere else |
| mv | MoVe a file or directory (basically rename) |
| rm | ReMove a file or directory |

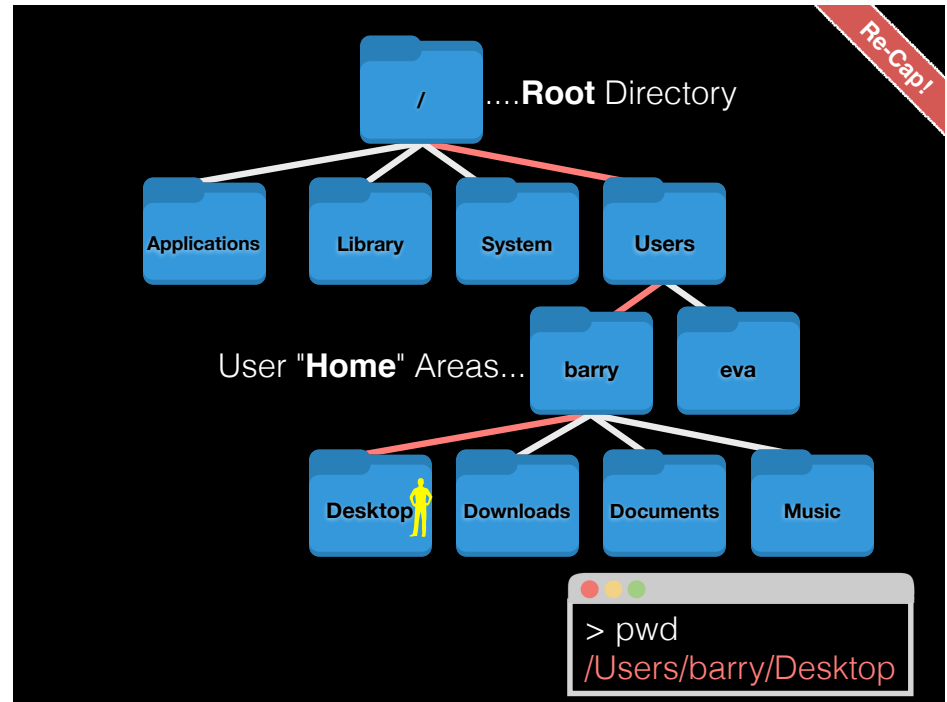
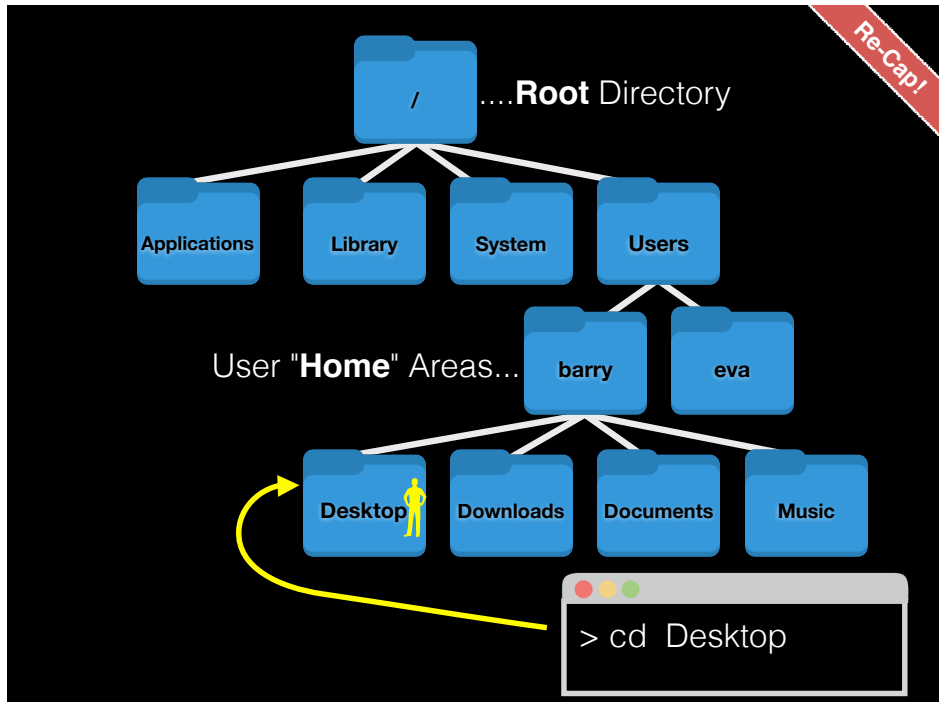
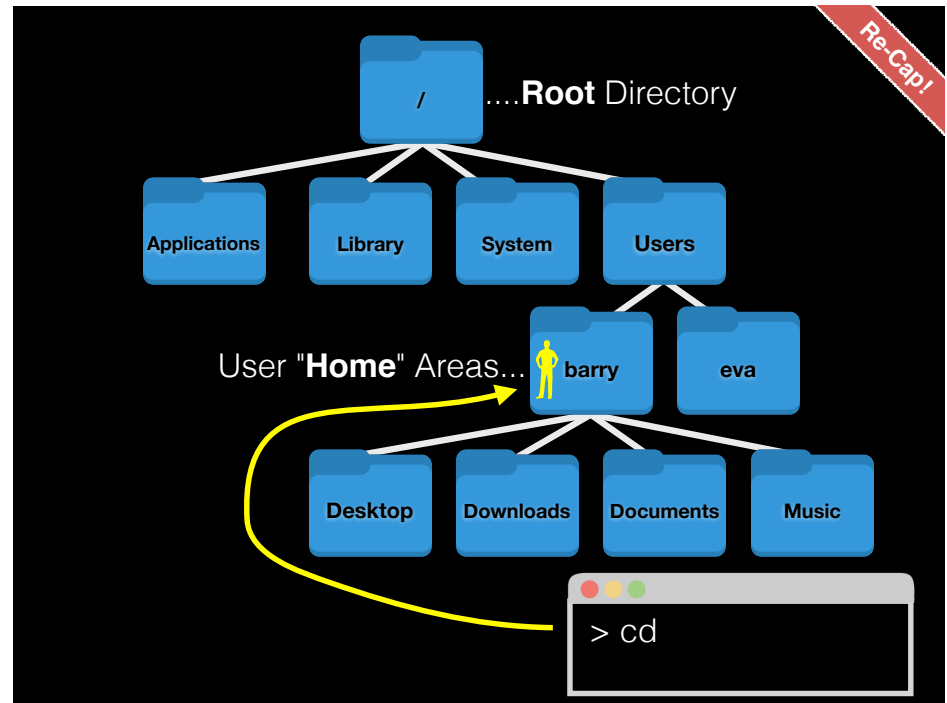
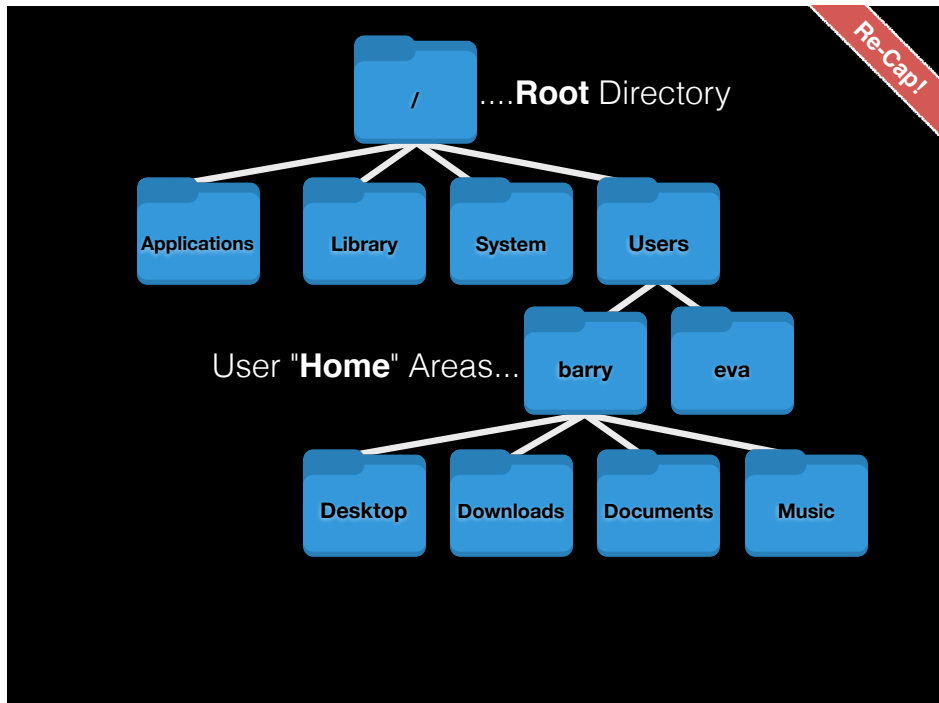

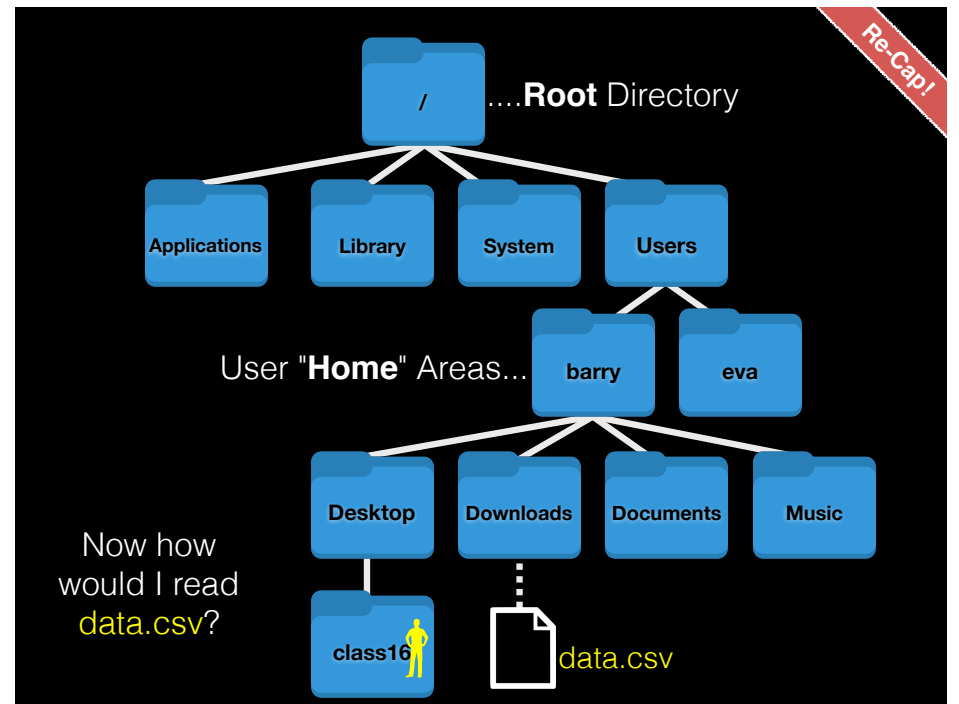
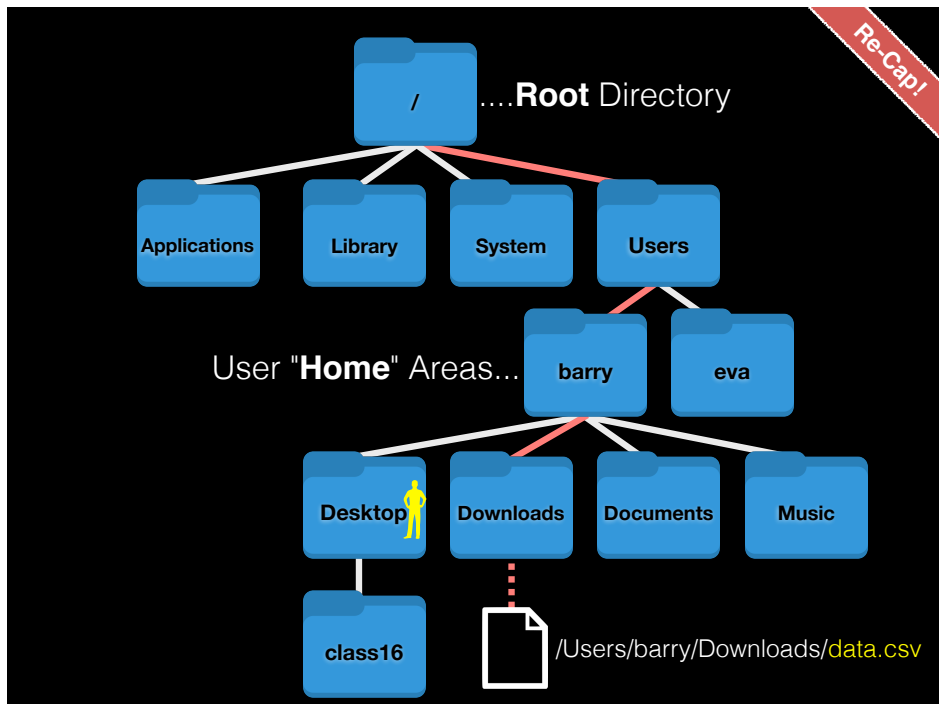
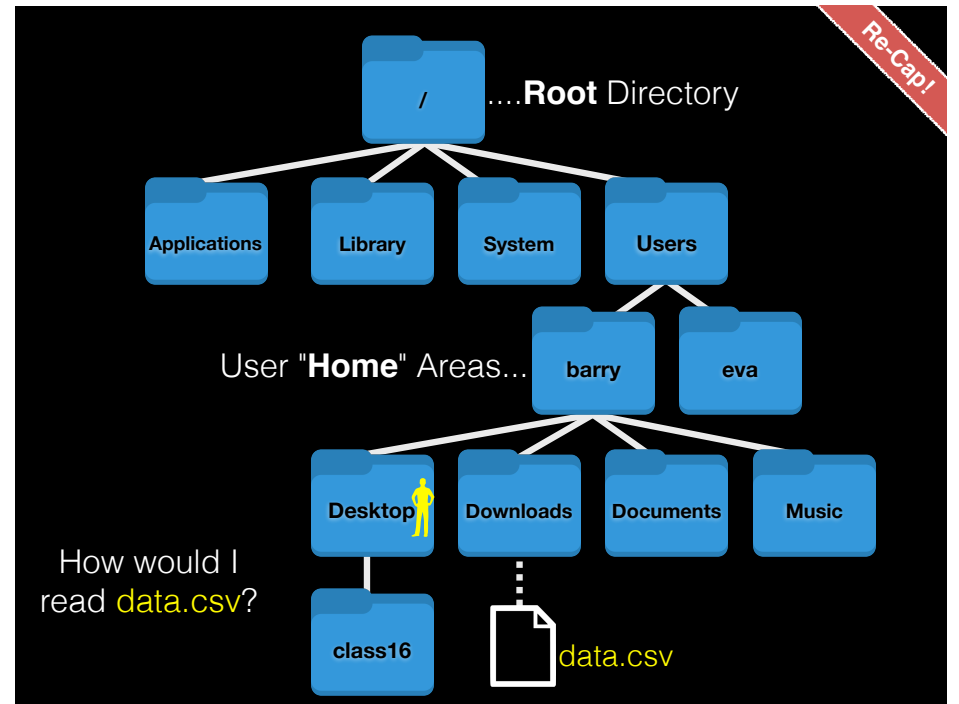
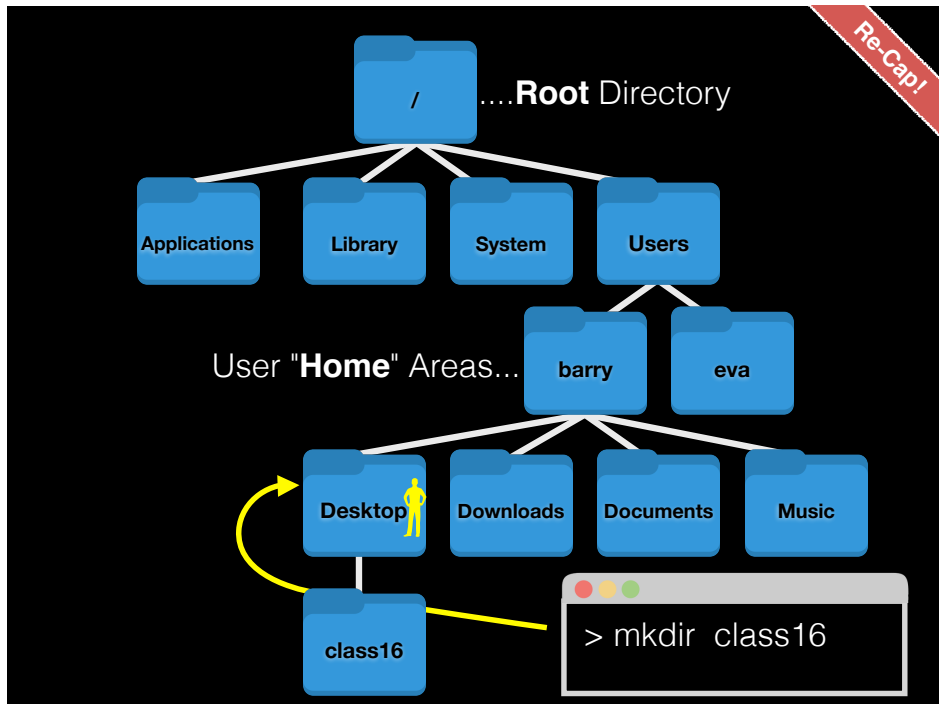

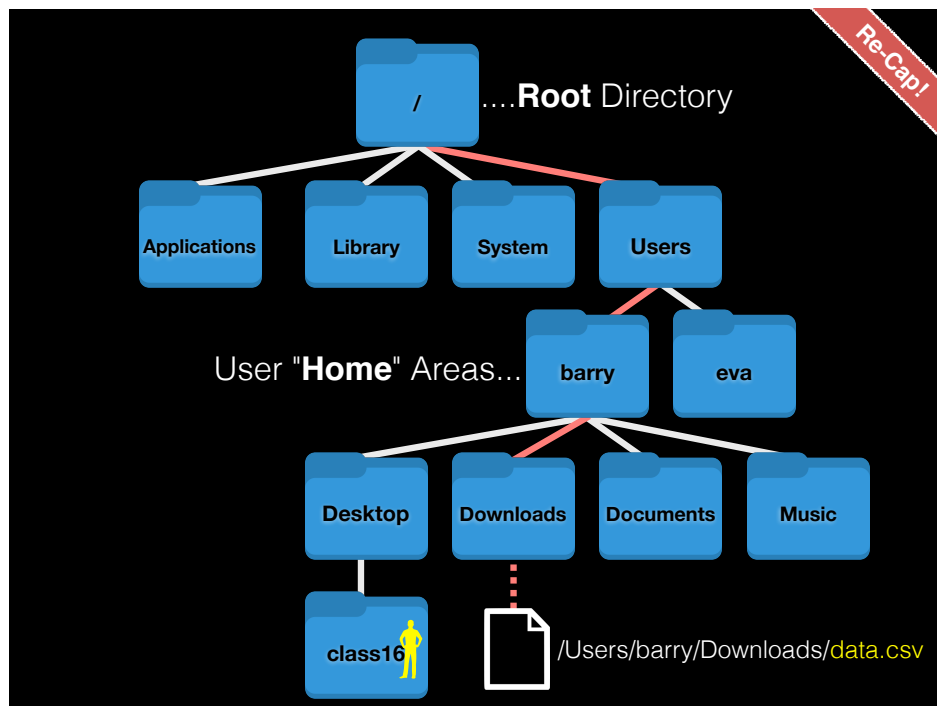

Side Note: File Paths

- An **absolute path** specifies a location from the root of the file system. E.g. `/Users/barry/Downloads/data.csv`
`~/Downloads/data.csv`
- A **relative path** specifies a location starting from the current location. E.g. `./data.csv`

| | |
|-------|--|
| . | Single dot '.' (for current directory) |
| .. | Double dot '..' (for parent directory, back one dir in our tree) |
| ~ | Tilda '~' (shortcut for your home directory) |
| [Tab] | Pressing the tab key can autocomplete names |

Finding the Right Hammer (**man** and **apropos**)

Not on Windows :-(

- You can access the manual (i.e. user documentation) on a command with **man**, e.g:
 - > `man pwd`
- The man page is only helpful if you know the name of the command you're looking for. **apropos** will search the man pages for keywords.
 - > `apropos "working directory"`

Windows only: > `pwd --help`

Inspecting text files

- **less** - visualize a text file:
 - use arrow keys
 - page down/page up with "space"/"b" keys
 - search by typing "/"
 - **quit** by typing "q"
- Also see: **head**, **tail**, **cat**, **more**

Creating text files

Creating files can be done in a few ways:

- With a **text editor** (such as **nano**, **emacs**, or **vi**)
- With the **touch** command (`> touch a_file`)
- From the command line with **cat** or **echo** and **redirection** (more on this later)
- **nano** is a simple text editor that is recommended for first-time users. Other text editors have more powerful features but also steep learning curves

Creating and editing text files with **nano**

Do it Yourself!

In the terminal type:

```
> nano yourfilename.txt
```

```
^G Get Help      ^O WriteOut     ^R Read File
^X Exit          ^J Justify      ^W Where Is
^Y Prev Page    ^K Cut Text     ^C Cur Pos
^V Next Page    ^U UnCut Txt   ^T To Spell
```

^ - Press Control

- There are many other text file editors (e.g. **vim**, **emacs** and **sublime text**, **atom** etc.)

Working with Unix

How do we actually use Unix?

| Basics | File Control | Viewing & Editing Files | Misc. useful | Power commands | Process related |
|------------|-----------------------|-------------------------|--------------|----------------|-----------------|
| ls | mv | less | chmod | grep | top |
| cd | cp | head | echo | find | ps |
| pwd | mkdir | tail | wc | sed | kill |
| man | rm | nano | curl | sudo | Ctrl-c |
| ssh | (pipe) | touch | source | git | Ctrl-z |
| | > (write to file) | | cat | R | bg |
| | < (read from file) | | | python | fg |

Combining Utilities with Redirection (>, <) and Pipes (|)

- The power of the shell lies in the ability to combine simple utilities (*i.e.* commands) into more complex algorithms very quickly.

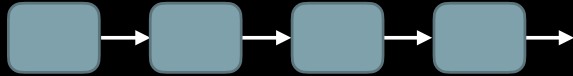

- A key element of this is the ability to send the output from one command into a file or to pass it directly to another program.
- This is the job of >, < and |

Side-Note: Standard Input and Standard Output streams

Two very important concepts that unpin Unix workflows:

- Standard Output (**stdout**) - default destination of a program's output. It is generally the terminal screen.
- Standard Input (**stdin**) - default source of a program's input. It is generally the command line.

Output redirection and piping



> ls ~/Desktop # stdin is “~/Desktop”; stdout to screen

Output redirection and piping

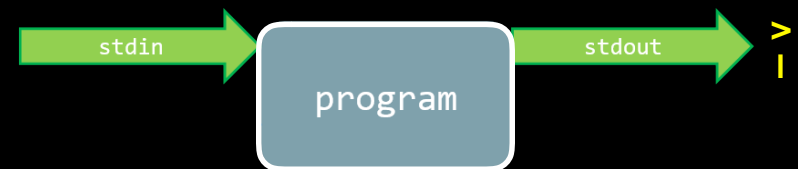

> ls ~/Desktop # stdin is “~/Desktop”; stdout to screen

> ls ~/Desktop > mylist.txt # stdout **redirected** to file

> ls ~/Desktop | less # stdout **piped** to less (no file created)

Output redirection and piping



- > ls ~/Desktop # stdin is "~/Desktop"; stdout to screen
- > ls ~/Desktop > mylist.txt # stdout **redirected** to file
- > ls ~/Desktop | less # stdout **piped** to less (no file created)
- > ls -l ~/Desktop # extra optional input **argument** "-l"

Output redirection and piping



- > ls ~/Desktop # stdin is "~/Desktop"; stdout to screen
- > ls ~/Desktop > mylist.txt # stdout **redirected** to file
- > ls ~/Desktop | less # stdout **piped** to less (no file created)
- > ls /nodirexists/ 2> binlist.txt # stderr to **file**

Output redirection and piping



- > ls ~/Desktop # stdin is "~/Desktop"; stdout to screen
- > ls ~/Desktop > mylist.txt # stdout **redirected** to file
- > ls ~/Desktop | less # stdout **piped** to less (no file created)
- > ls /nodirexists/ 2> binlist.txt # stderr to **file**

Output redirection and piping

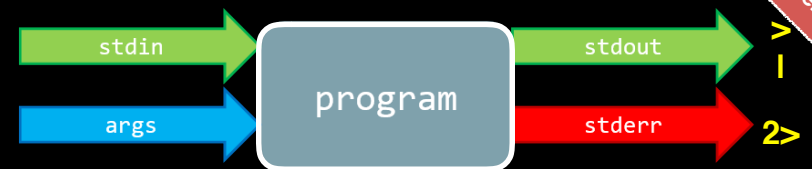

- > ls ~/Desktop # stdin is "~/Desktop"; stdout to screen
- > ls ~/Desktop > mylist.txt # stdout **redirected** to file
- > ls ~/Desktop | less # stdout **piped** to less (no file created)
- > ls /nodirexists/ 2> binlist.txt # stderr to **file**

Output redirection summary

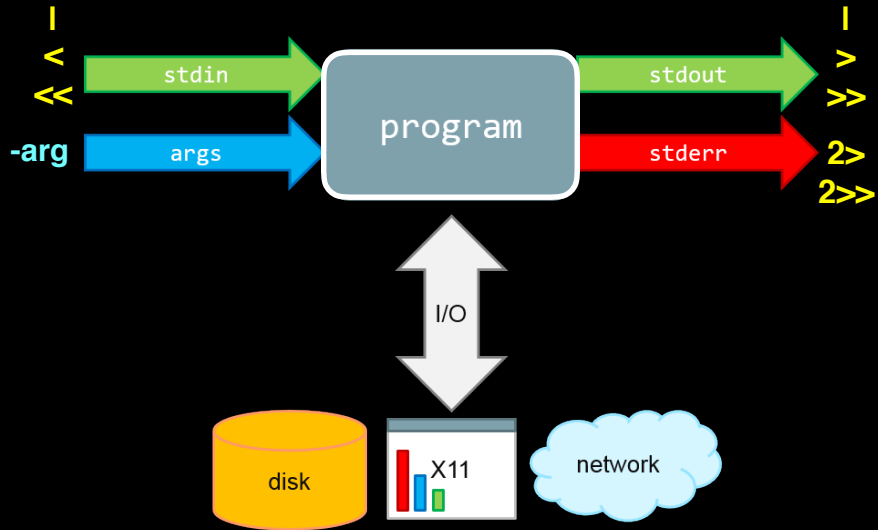

ls -l

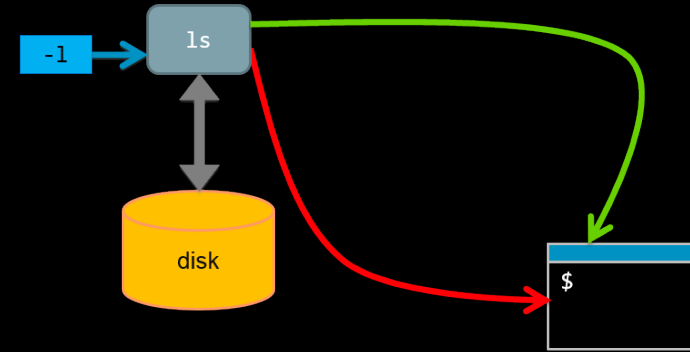

ls -l > list_of_files

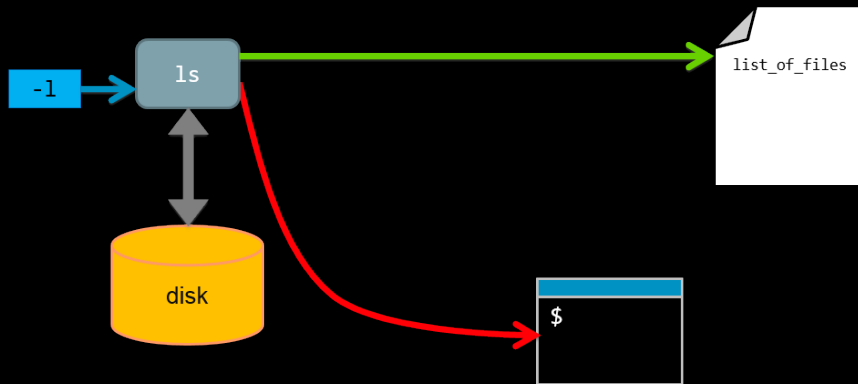

ls -l | grep partial_name > list_of_files

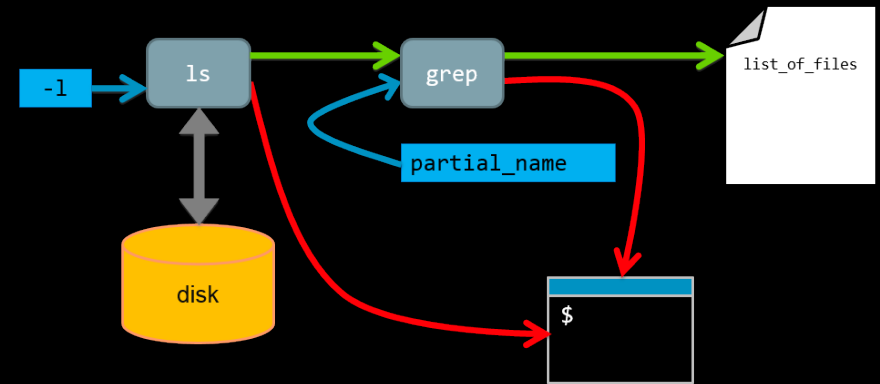

We have **piped** (|) the **stdout** of one command into the **stdin** of another command!

ls -l /usr/bin/ | grep "tree" > list_of_files

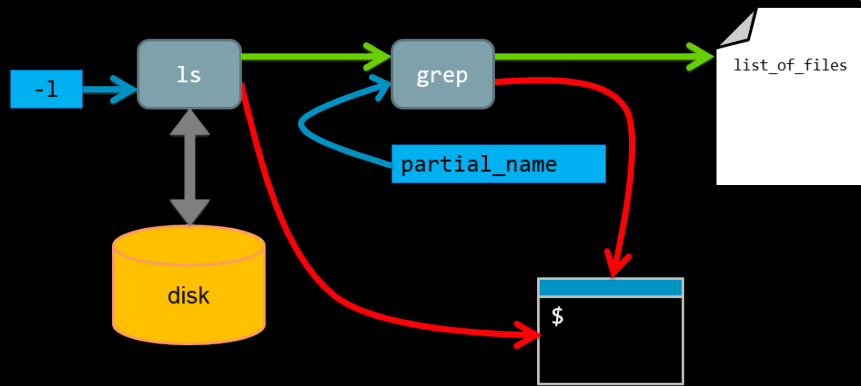

grep: prints lines containing a string.
Also searches for strings in text files.

Do it Yourself!

| Basics | File Control | Viewing & Editing Files | Misc. useful | Power commands | Process related |
|--------|-----------------------|-------------------------|--------------|----------------|-----------------|
| ls | mv | less | chmod | grep | top |
| cd | cp | head | echo | find | ps |
| pwd | mkdir | tail | wc | sed | kill |
| man | rm | nano | curl | sudo | Ctrl-c |
| ssh | (pipe) | touch | source | git | Ctrl-z |
| scp | > (write to file) | | cat | R | bg |
| | < (read from file) | | tmux | python | fg |

Side-Note: grep 'power command'

- **grep** - prints lines containing a string pattern. Also searches for strings in text files, e.g.

> cd ~/bggn213_01_unix/projects/transducin/sequences/data/

> grep --color "GESGKS" seqdump.fasta

REVLLLLLG**GESGKS**TIVKQMKIIIHEAGYSEEECKQYK

- grep is a 'power tool' that is often used with pipes as it accepts **regular expressions** as input (e.g. "**G..GK[ST]**") and has lots of useful options - see the [man page](#) for details.

Do it Yourself!

grep example using regular expressions

- Suppose a program that you are working with complains that your input sequence file contains non-nucleotide characters. You can eye-ball your file or ...

> grep -v "^>" seqdump.fasta | grep --color "[^ATGC]"

Exercises:

(1). Use "man grep" (or on windows "grep --help") to find out what the -v argument option is doing!

(2). How could we also show line number for each match along with the output?

(tip you can grep the output of "man grep" for 'line number')

Do it Yourself!

grep example using regular expressions

Do it Yourself!

- Suppose a program that you are working with complains that your input sequence file contains non-nucleotide characters. You can eye-ball your file or ...

```
> grep -v "^>" seqdump.fasta | grep --color -n "[^ATGC]"
```

- First we remove (with **-v** option) lines that start with a ">" character (these are sequence identifiers).
- Next we find characters that are *not* A, T, C or G. To do this we use ^ symbols second meaning: *match anything but* the pattern in square brackets. We also print line number (with **-n** option) and color output (with **--color** option).

Key Point: Pipes and redirects avoid unnecessary i/o

- Disc i/o is often a bottleneck in data processing!
- Pipes prevent unnecessary disc i/o operations by connecting the stdout of one process to the stdin of another (these are frequently called "**streams**")

```
> program1 input.txt 2> program1.stderr | \
program2 2> program2.stderr > results.txt
```

- Pipes and redirects allow us to build solutions from modular parts that work with **stdin** and **stdout streams**.

Unix 'Philosophy' Revisited

"Write programs that do one thing and do it well. Write programs to work together and that encourage open standards. Write programs to handle text streams, because that is a universal interface."



— Doug McIlroy

Pipes provide speed, flexibility and sometimes simplicity...

- In 1986 "*Communications of the ACM magazine*" asked famous computer scientist Donald Knuth to write a simple program to count and print the *k* most common words in a file alongside their counts, in descending order.
- Knuth wrote a literate programming solution that was 7 pages long, and also highly customized to this problem (e.g. Knuth implemented a custom data structure for counting English words).
- Doug McIlroy replied with one line:

```
> cat input.txt | tr A-Z a-z | sort | uniq -c | sort -rn | sed 10q
```

Key Point:

You can chain any number of programs together to achieve your goal!



This allows you to build up fairly complex workflows within one command-line.

| Basics | File Control | Viewing & Editing Files | Misc. useful | Power commands | Process related |
|------------|-----------------------|-------------------------|--------------|----------------|-----------------|
| ls | mv | less | chmod | grep | top |
| cd | cp | head | echo | find | ps |
| pwd | mkdir | tail | wc | sed | kill |
| man | rm | nano | curl | sudo | Ctrl-c |
| ssh | (pipe) | touch | source | git | Ctrl-z |
| | > (write to file) | | cat | R | bg |
| | < (read from file) | | | python | fg |

Do it Yourself!

Hands-on time

Using AWS for Bioinformatics

- Using remote UNIX machines (Part I)
- Using remote UNIX machines (Part II)
- Using remote UNIX machines (Part III)

~75 mins

New commands

| | |
|----------------|---|
| sudo | Execute a command with root permissions |
| apt-get | Package handling utility for updating & installing software |
| curl | Download data |
| gunzip | File compression and decompression |
| blastp | Command line BLAST |
| shmlast | Mapping orthologs from RNA-seq data |
| ? | Use man to find out about other new commands |

Connecting to remote machines (with **ssh**)

Most high-performance computing (HPC) resources can only be accessed by **ssh** (Secure **S**hell)

```
> ssh [user@host.address]
```

For example:

```
> ssh barry@bio3d.ucsd.edu
      User   Host address
```

Connecting to AWS (with **ssh**)

- We will go through this process together in the last hands-on sections today!

- ✓ Downloaded our class specific **keyfile** (See web link on board or your email: This is required for connecting to AWS virtual machines later.)

- ✓ Use your **username** and assigned **IP_ADDRESS**

```
> ssh -i ~/Downloads/ssh_key ubuntu@IP_ADDRESS
      Optional key file   User   Host address
```

Copying to and from remote machines (**scp**)

- The **scp** (Secure **C**o**P**y) command can be used to copy files and directories from one computer to another.

```
> scp [file] [user@host]:[destination]
> scp localfile.txt barry@bigcomputer.net:/remotedir/
```

| Basics | File Control | Viewing & Editing Files | Misc. useful | Power commands | Process related |
|--------|-----------------------|-------------------------|--------------|----------------|-----------------|
| ls | mv | less | chmod | grep | top |
| cd | cp | head | echo | find | ps |
| pwd | mkdir | tail | wc | sed | kill |
| man | rm | nano | curl | sudo | Ctrl-c |
| ssh | (pipe) | touch | source | git | Ctrl-z |
| scp | > (write to file) | | cat | R | bg |
| | < (read from file) | | tmux | python | fg |

Process refers to a running instance of a program

| | |
|---------------|--|
| top | Provides a real-time view of all running processes |
| ps | Report a snapshot of the current processes |
| kill | Terminate a process (the "force quit" of the unix world) |
| Ctrl-c | Stop a job |
| Ctrl-z | Suspend a job |
| bg | Resume a suspended job in the background |
| fg | Resume a suspended job in the foreground |
| & | Start a job in the background |

Do it Yourself!

Hands-on time

Sections 1 to 3 of software carpentry UNIX lesson

<https://swcarpentry.github.io/shell-novice/>

Do This at Home!

<https://explainshell.com>

- Many bioinformatics tools can only be used through a command line interface, or have extra capabilities in the command line version that are not available in the GUI.
- The shell makes your work less error-prone, more reproducible and less boring allowing you to automate repetitive tasks and concentrate on more exciting things.
- Many bioinformatic tasks require large amounts of computing power and can't realistically be run on your own machine. These tasks are best performed using **remote computers** or **cloud computing**, which can only be accessed through a shell.

How to Get Working

Best practices for organizing your computational biology projects

Read: Noble PLoS Comp Biol (2009)

- "A Quick Guide to Organizing Computational Biology Projects"
<http://journals.plos.org/plocompbiol/article?id=10.1371/journal.pcbi.1000424>

All files and directories used in your project should live in a single project directory.

- Use sub-directories to divide your project into sub-projects.
- Do not use spaces in file and directory names!

Document your methods and workflows with plain text README files

- Also document the origin of all data in your project directory
- Also document the versions of the software that you ran and the options you used.
- Consider using Markdown for your documentation.

Use version control and backup to multiple destinations!

Be reproducible:

<http://ropensci.github.io/reproducibility-guide/sections/introduction/>

Geeks and repetitive tasks

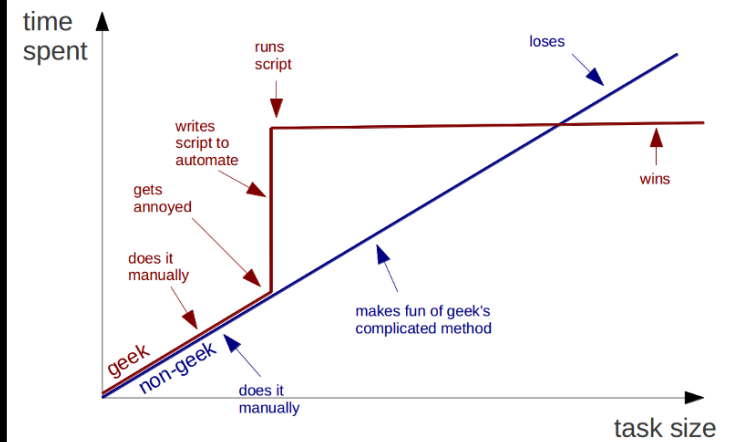

Summary

- Built-in unix shell commands allow for easy data manipulation (e.g. sort, grep, etc.)
- Commands can be easily combined to generate flexible solutions to data manipulation tasks.
- The unix shell allows users to automate repetitive tasks through the use of shell scripts that promote reproducibility and easy troubleshooting
- Introduced the 21 key unix commands that you will use during ~95% of your future unix work...